

A地 (複合施設)

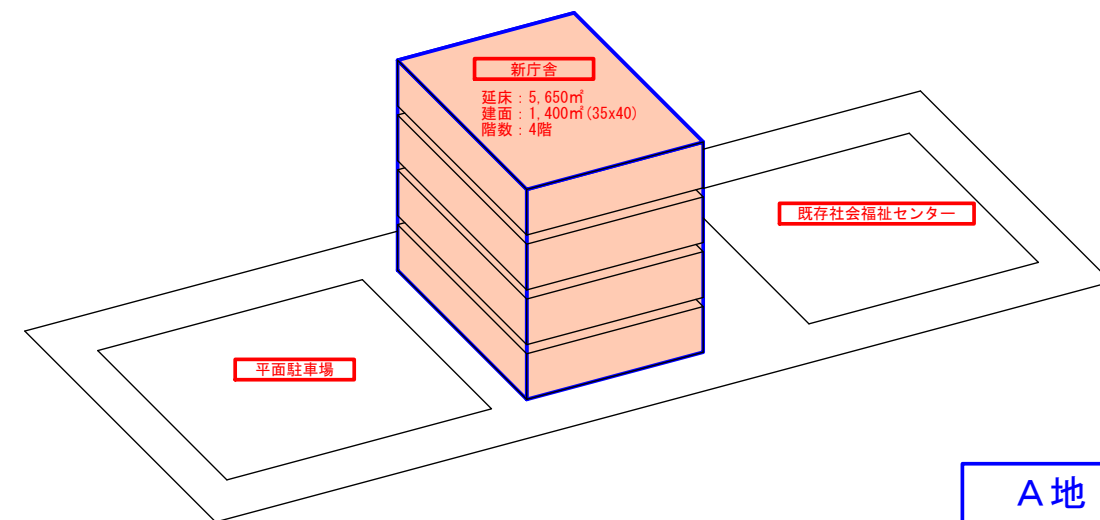

A地 (庁舎単独)

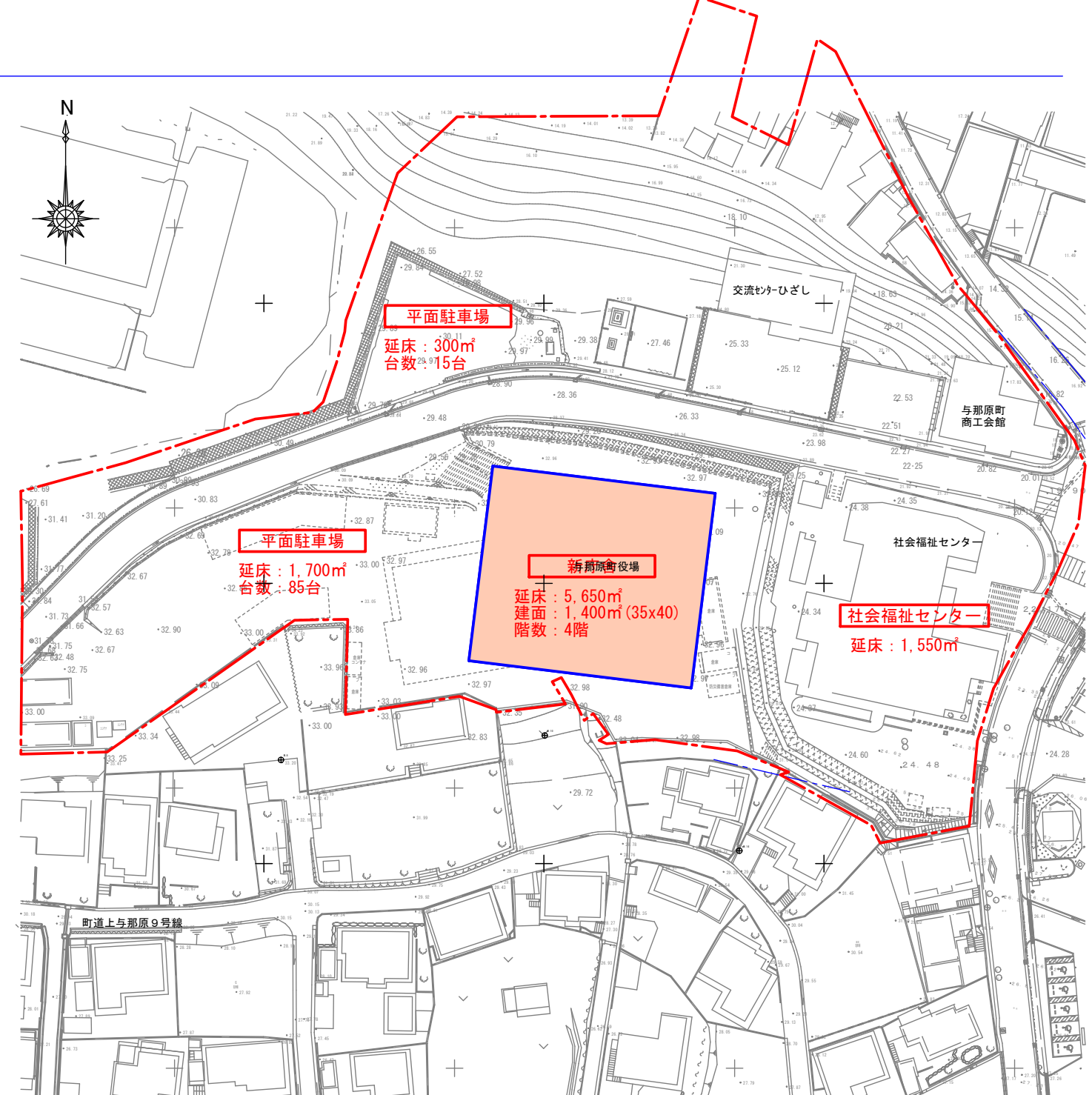

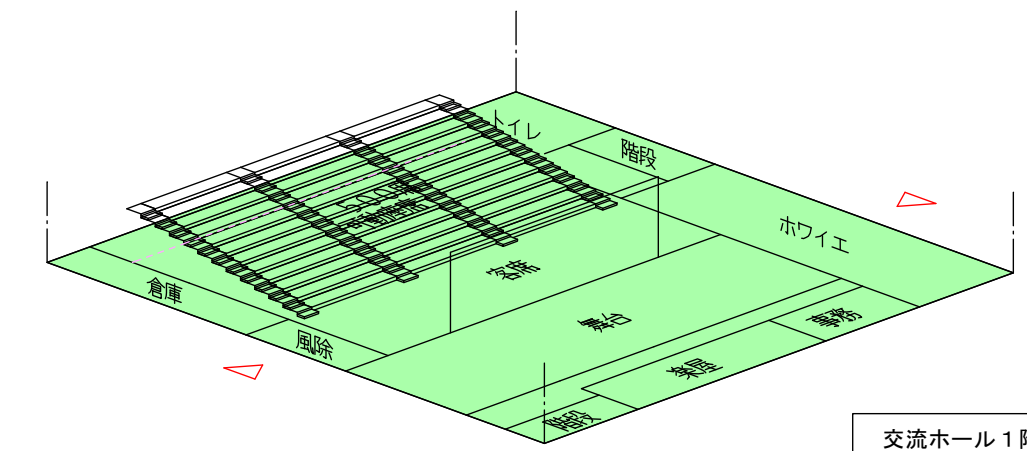
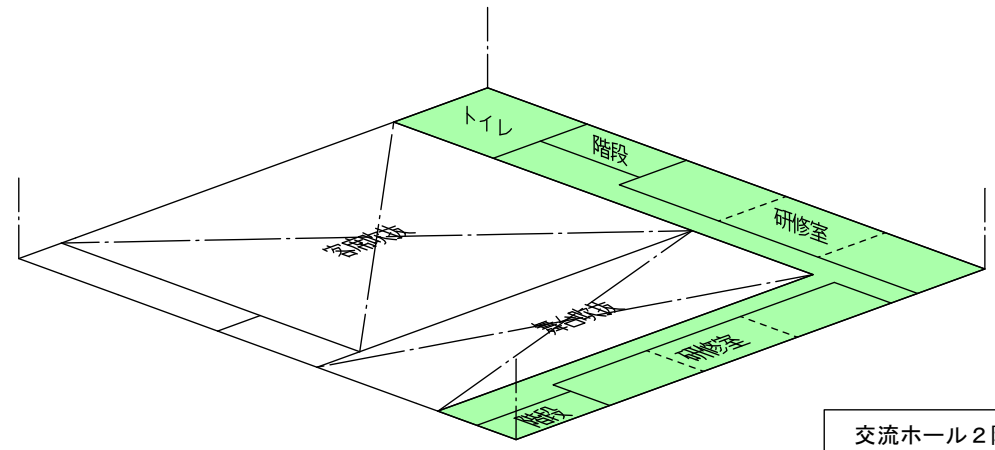
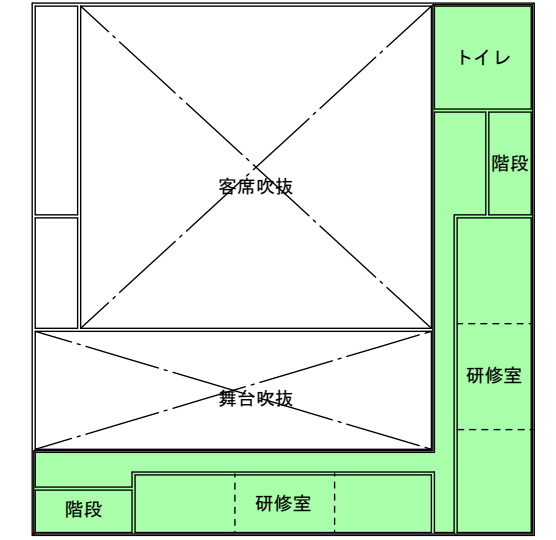
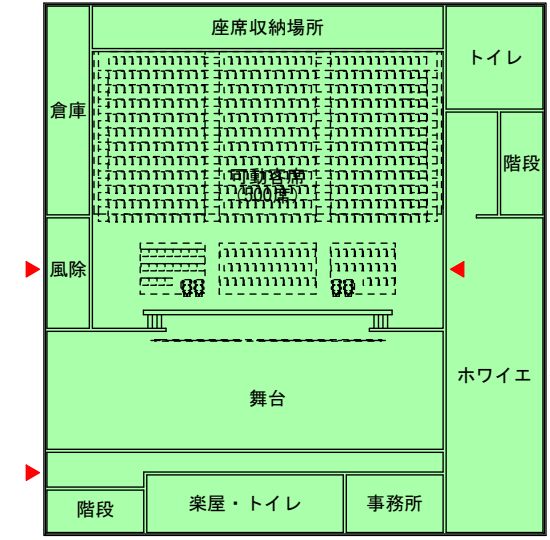
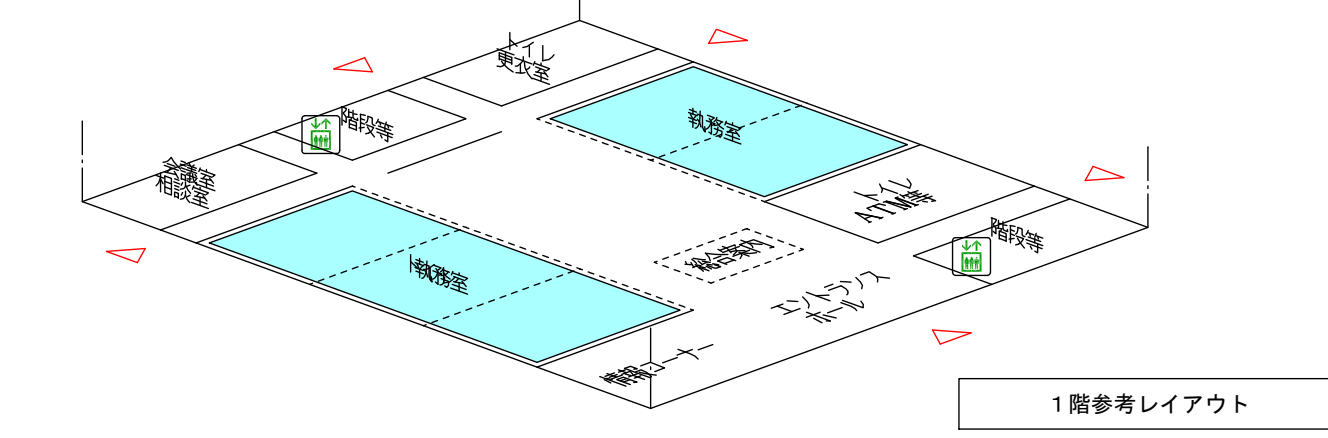
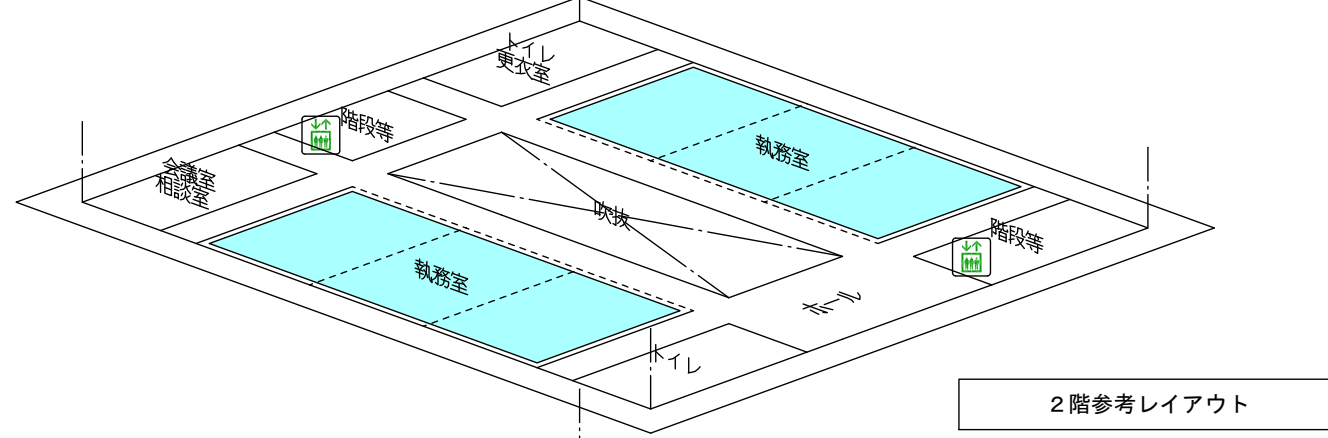
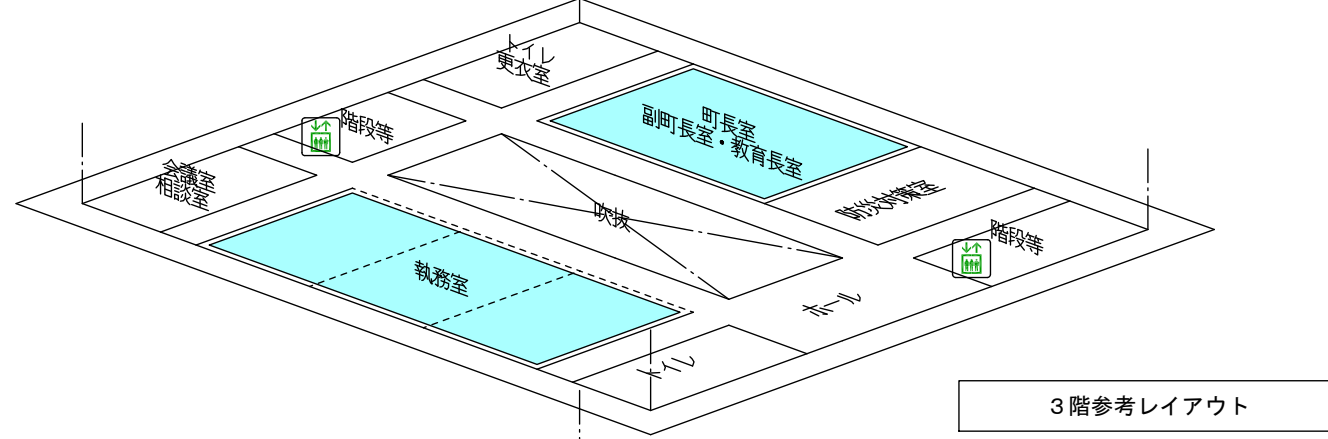
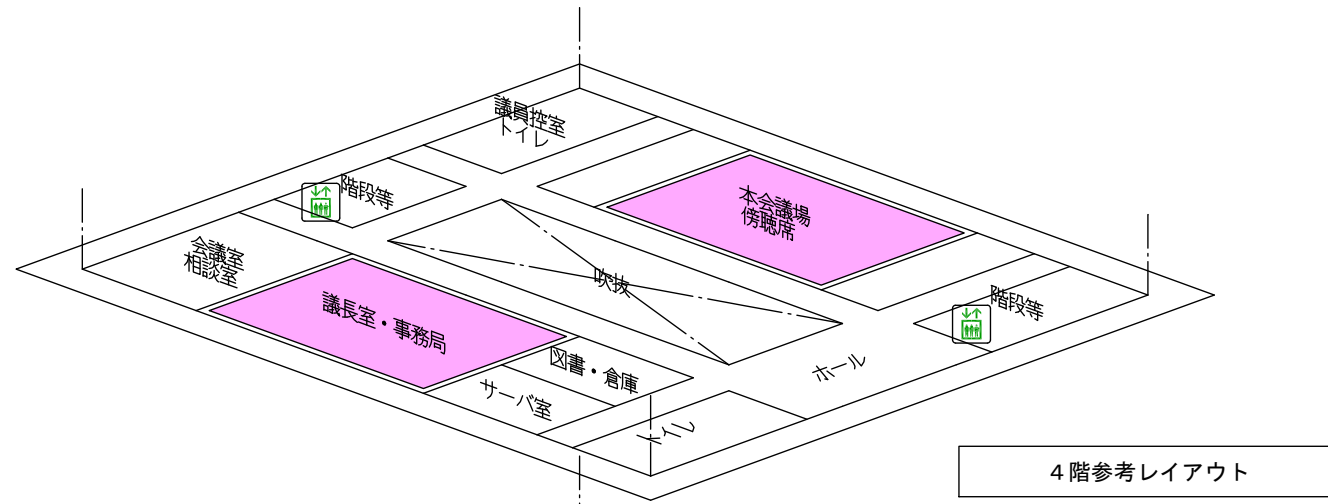
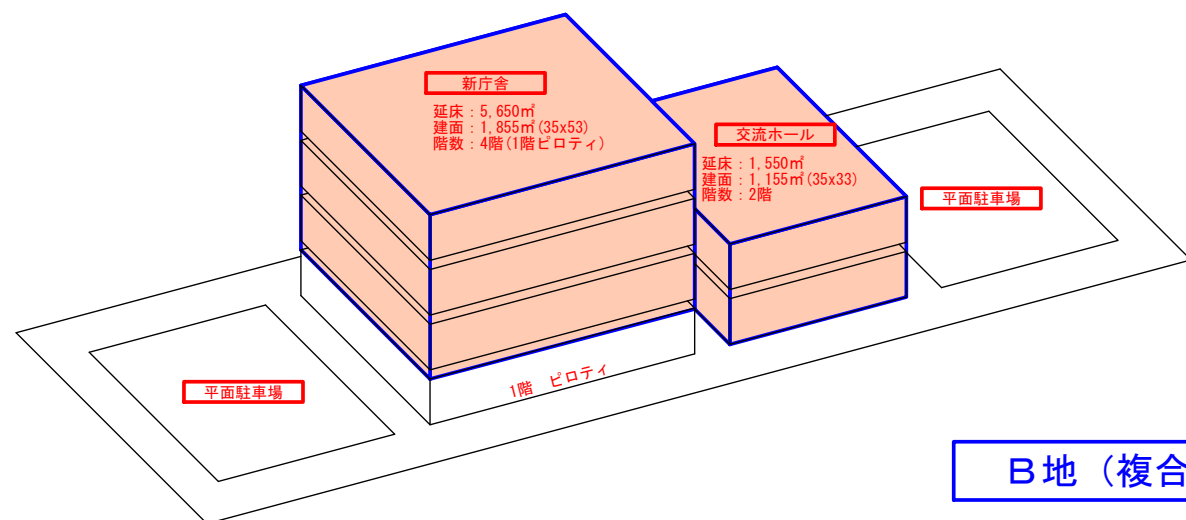
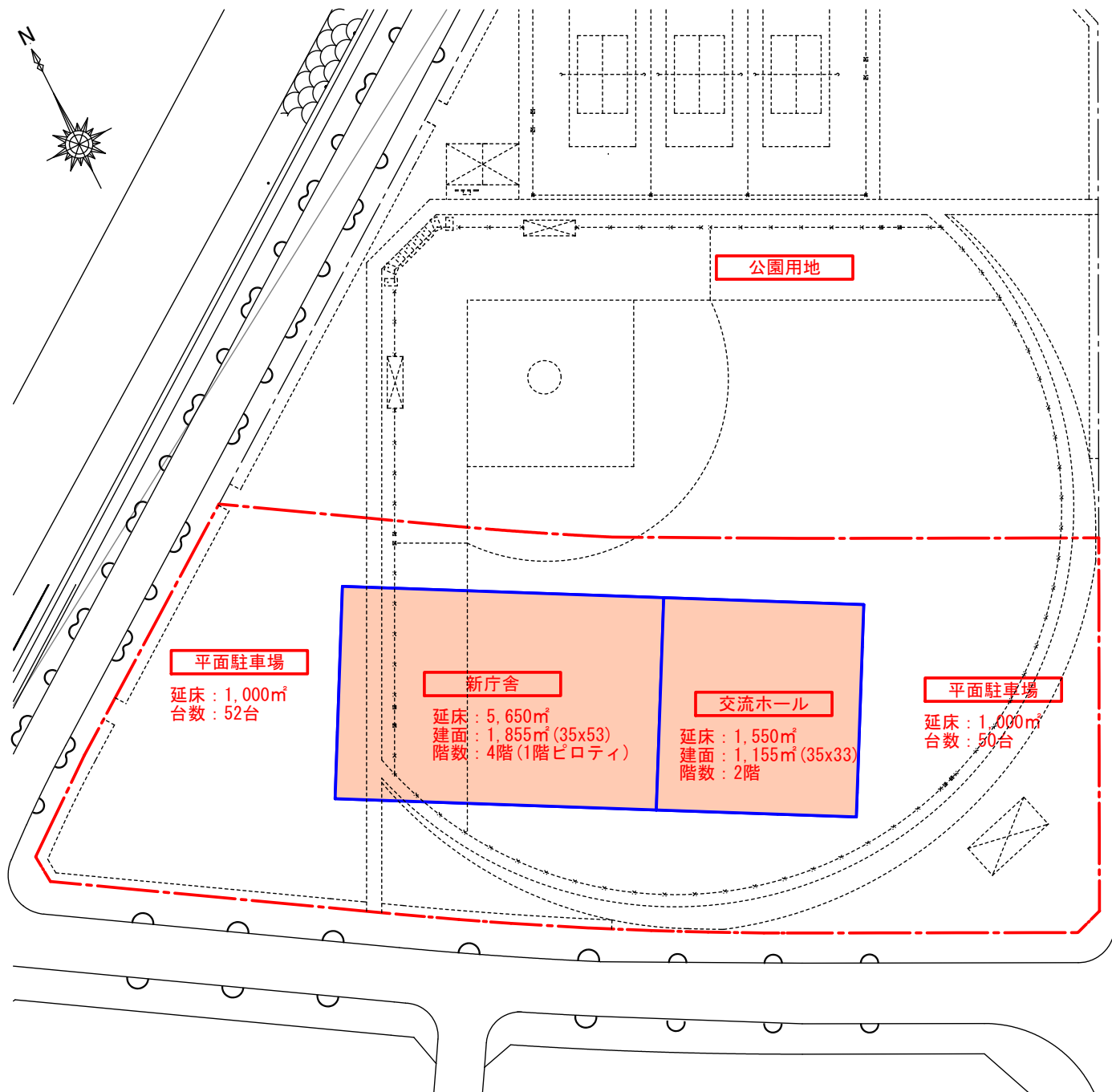

B地 (複合施設)

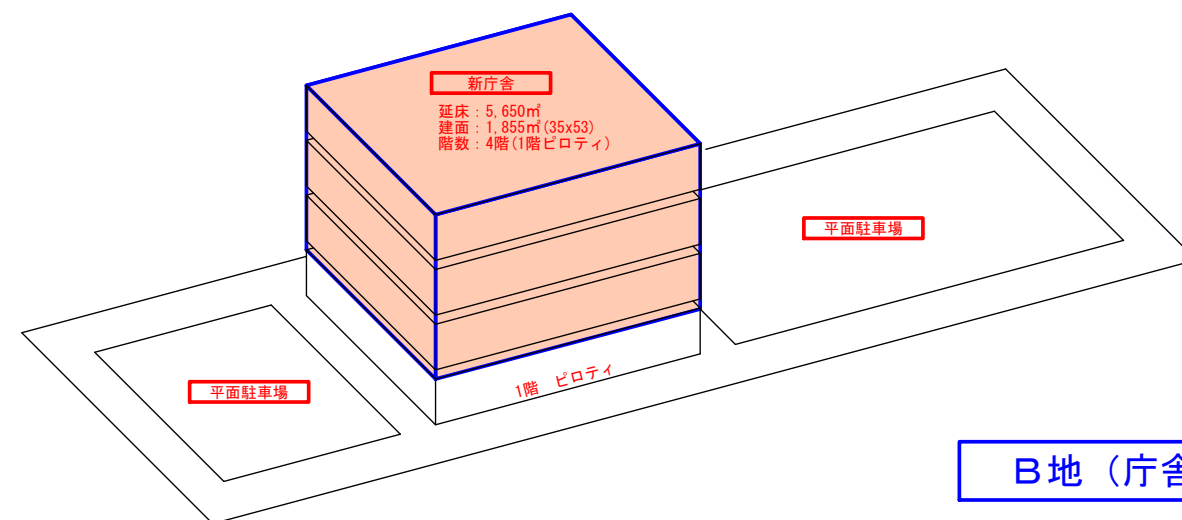
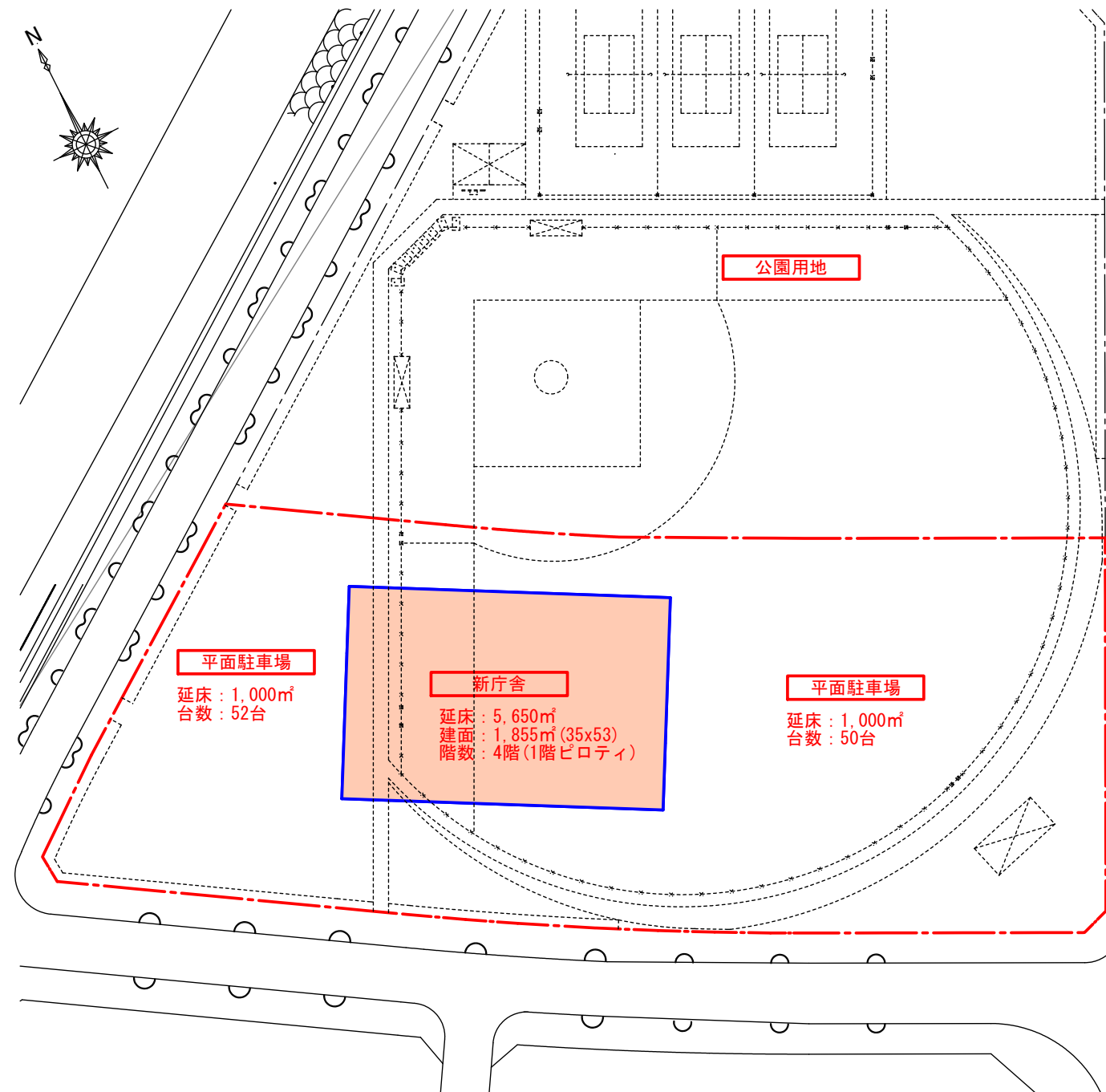

B地 (庁舎単独)

